

Datenblatt:



DB 976+1**9+000 TSS Office Protect 120 / 140 / 160

TSS

Ausgegeben von iprint am 14.06.2022 / 10:03

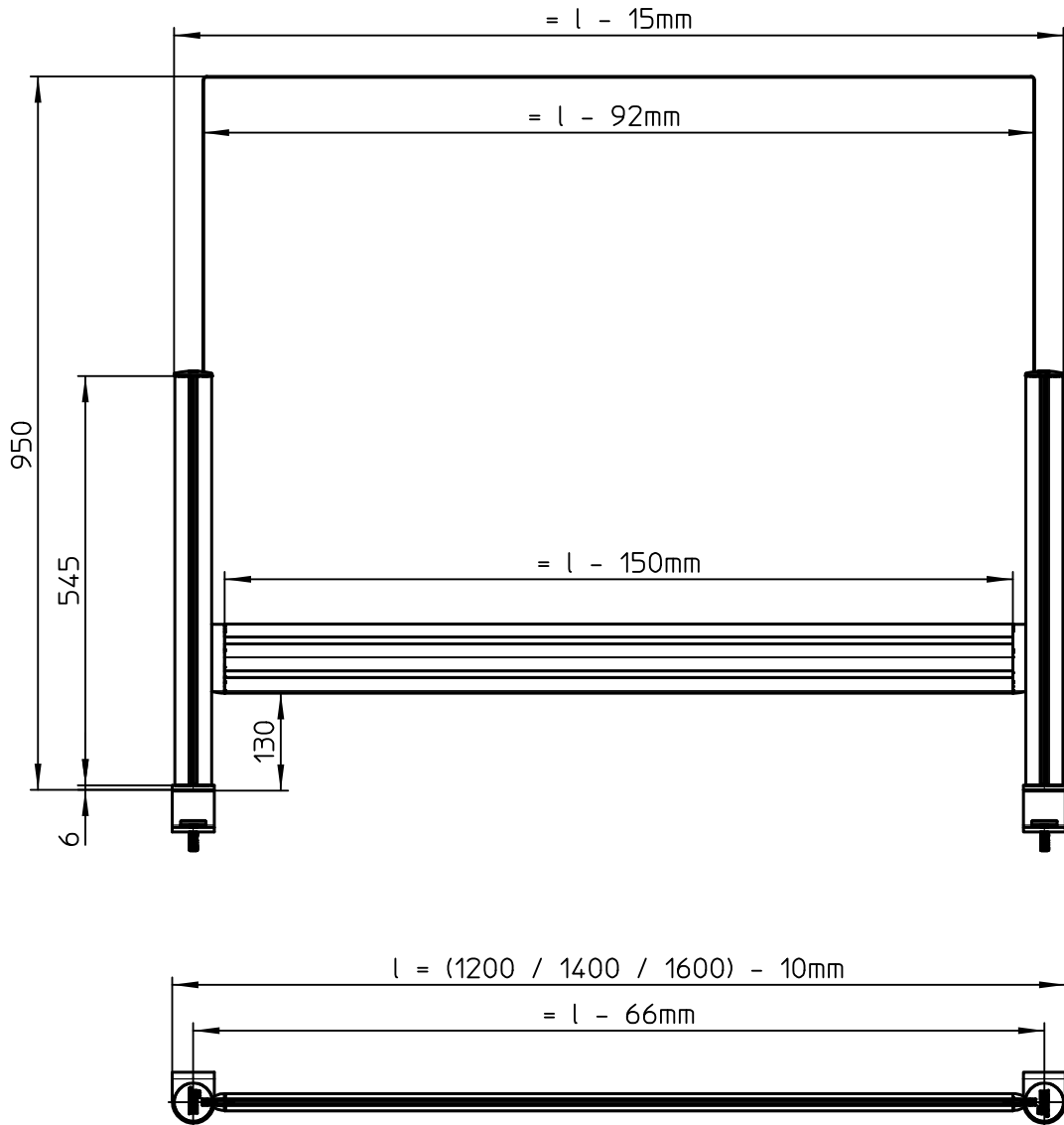

976+1*09+000
TSS Office Protect 1*0 c
c = clamp

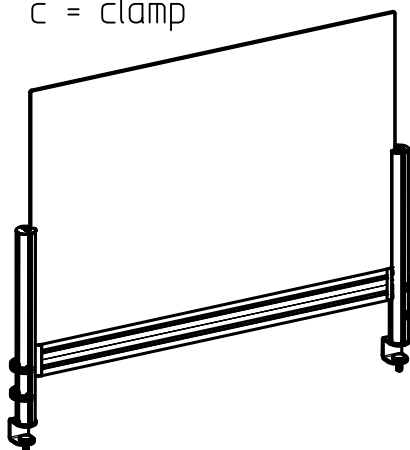

976+1*19+000
TSS Office Protect 1*0
ohne Befestigung

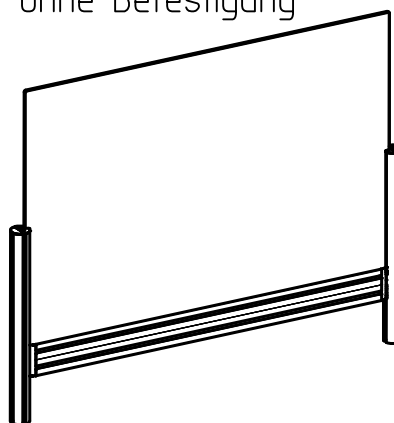

Technische und Design Änderungen vorbehalten!
Technical and design modifications reserved! 09.06.20